

Loft Bestuhlung

Auf den folgenden Seiten finden Sie einige Bestuhlungsvarianten:

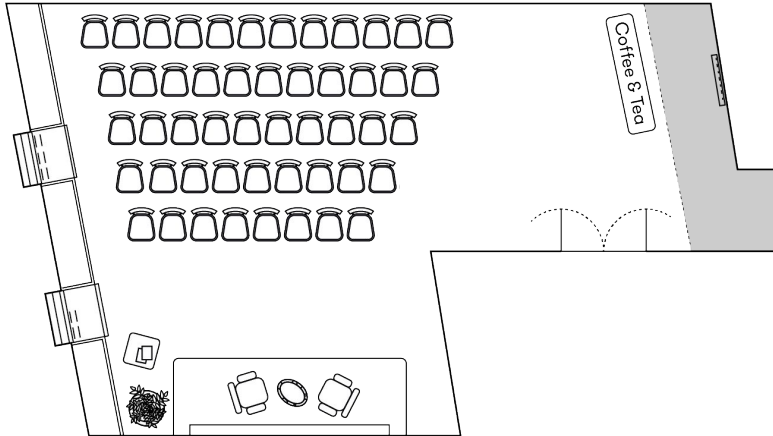

Konzert

Kapazität
50 Personen

Tische in Reserve
7 Gross (200x75)
5 Klein (150x75)

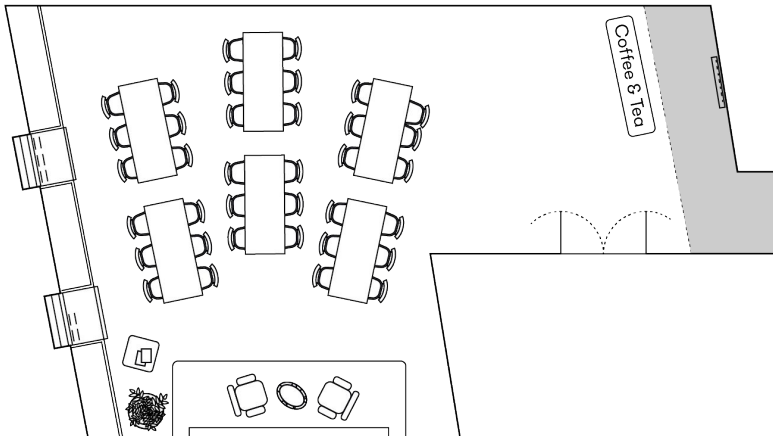

Tischinsel V1

Kapazität
36 Personen

Tische in Reserve
1 Gross (200x75)
5 Klein (150x75)

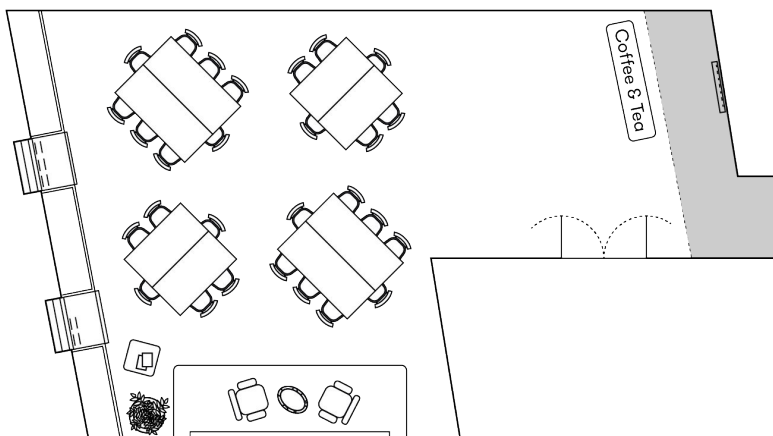

Tischinsel V2

Kapazität
28 Personen

Tische in Reserve
3 Gross (200x75)
1 Klein (150x75)

Loft Bestuhlung

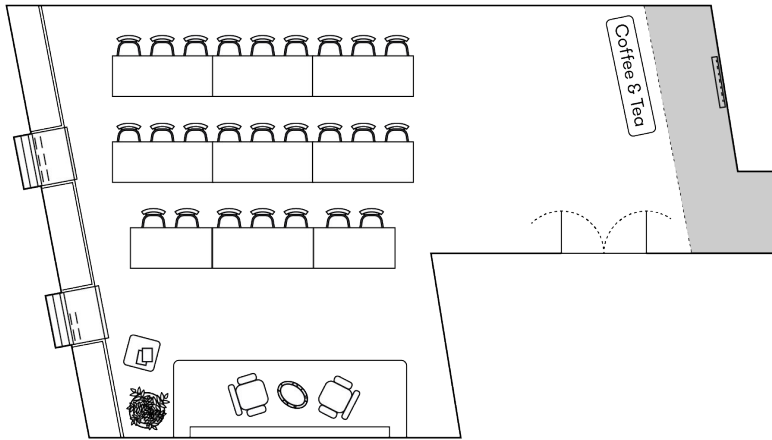

Seminar

Kapazität

25 Personen

Tische in Reserve

0 Gross (200x75)

3 Klein (150x75)

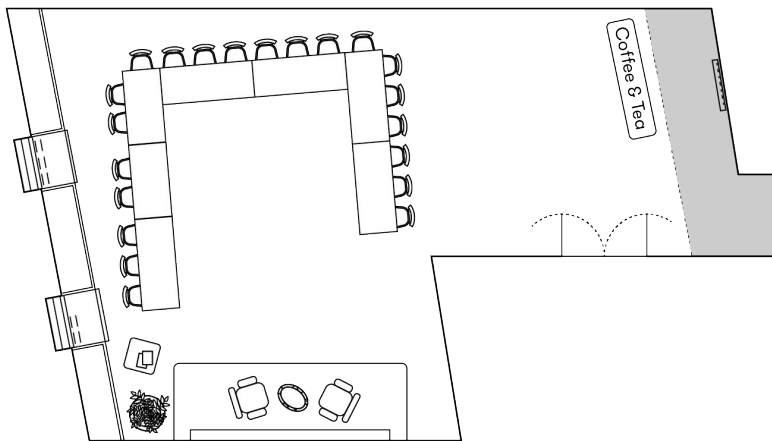

U-Form

Kapazität

20 Personen

Tische in Reserve

2 Gross (200x75)

3 Klein (150x75)

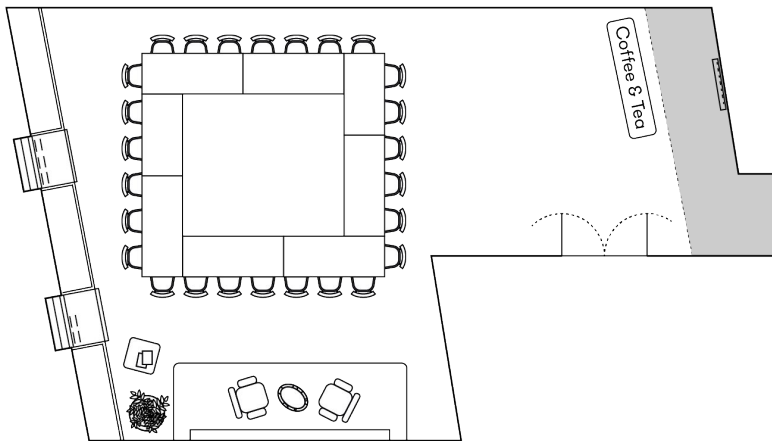

Quadrat

Kapazität

26 Personen

Tische in Reserve

1 Gross (200x75)

3 Klein (150x75)

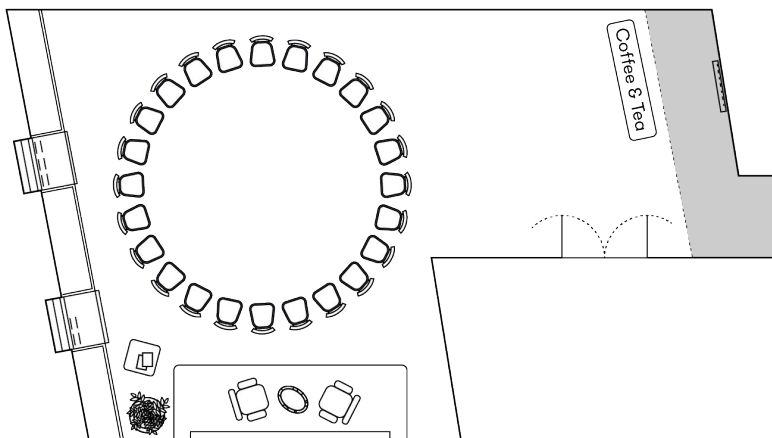

Kreis

Kapazität

24 Personen

Tische in Reserve

7 Gross (200x75)

5 Klein (150x75)

Loft Bestuhlung

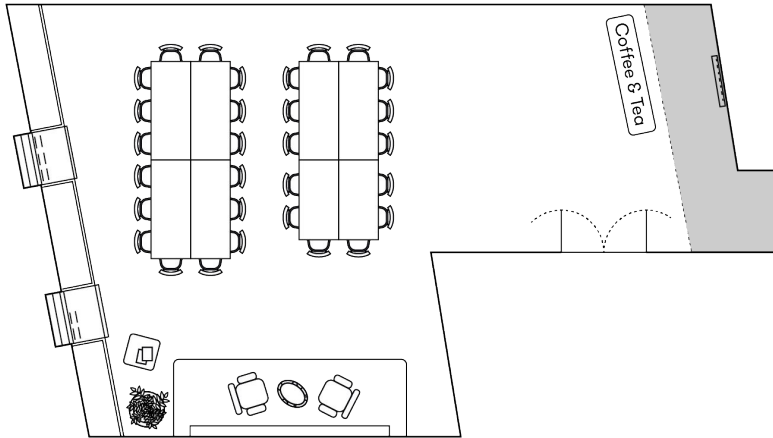

Block V1

Kapazität

30 Personen

Tische in Reserve

1 Gross (200x75)

3 Klein (150x75)

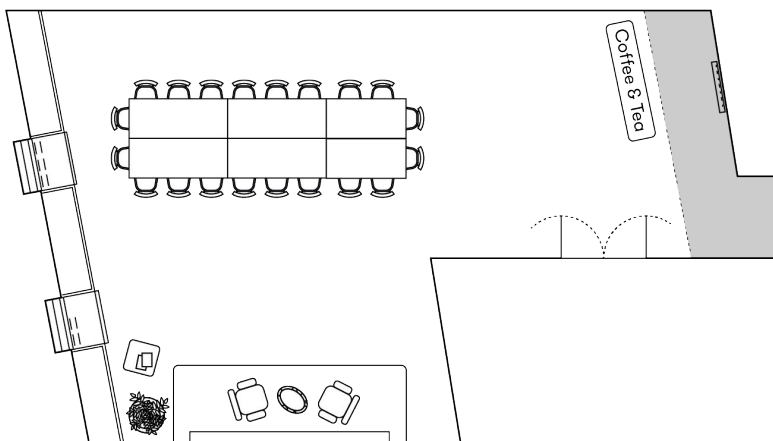

Block V2

Kapazität

20 Personen

Tische in Reserve

3 Gross (200x75)

3 Klein (150x75)

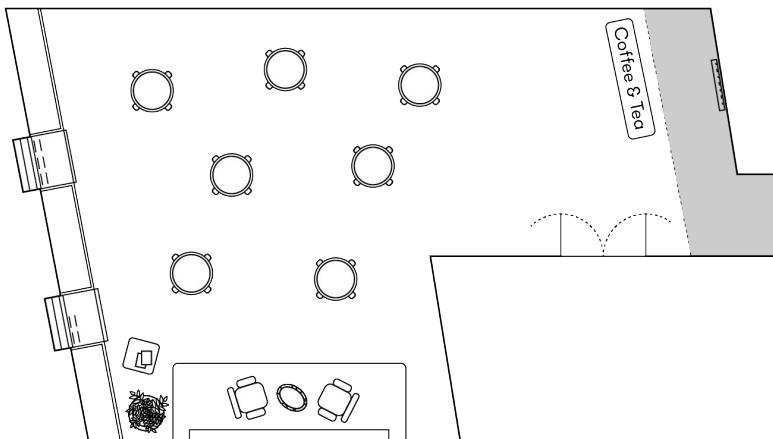

Apèro (Stehtische)

Kapazität

42 Personen

Tische in Reserve

7 Gross (200x75)

5 Klein (150x75)

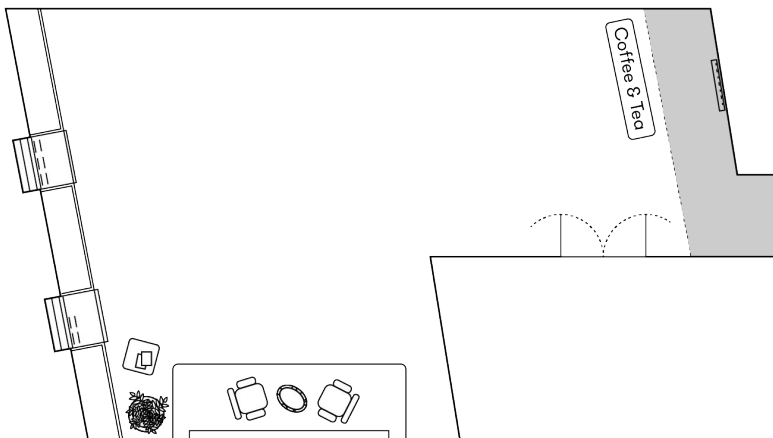

Ohne Bestuhlung

Kapazität

65 Personen

Tische in Reserve

7 Gross (200x75)

5 Klein (150x75)